



## STORAGE AND KENNELS

SHEDS



## SUMMERHOUSES



PLAYHOUSES



# introduction

At TGB Sheds we manufacture a comprehensive range of quality garden buildings. We take great care and pride in our attention to detail and feel confident you will find a product suitable for your needs. Many options are available for all our buildings, these include; 22mm floorboards, 22mm premier cladding, 19mm log effect cladding, security products, 38mm x 50mm framing as standard, 50mm x 50mm and 50mm x 75mm framing, pressure treated tanalised timber, additional doors and windows, and increased eaves heights. If you cannot find a building to suit your needs please enquire about a custom built model as we cater for our customer needs.

We are a progressive forward thinking company and in-line with our policy of continual development and improvement reserve the right to change specifications, designs and prices without notice.

All buildings are pre-treated with quality water based wood preservative prior to delivery.\* To ensure longevity we recommend a top coat upon installation, and annually thereafter. Timber is a natural product, subject to changes caused by environmental conditions, to minimise contraction and expansion it is essential to maintain your building.

All timber sizes are nominal, before machining unless stated.

All building dimensions shown are approximate, based on external wall sizes, allowances should be made for roof overhangs when locating your building in a confined space.

All glass used is 3mm horticultural unless otherwise stated.



\* This does not include the tanalised timber

Specifications of timber used. All sizes are nominal (before machining) unless otherwise stated.

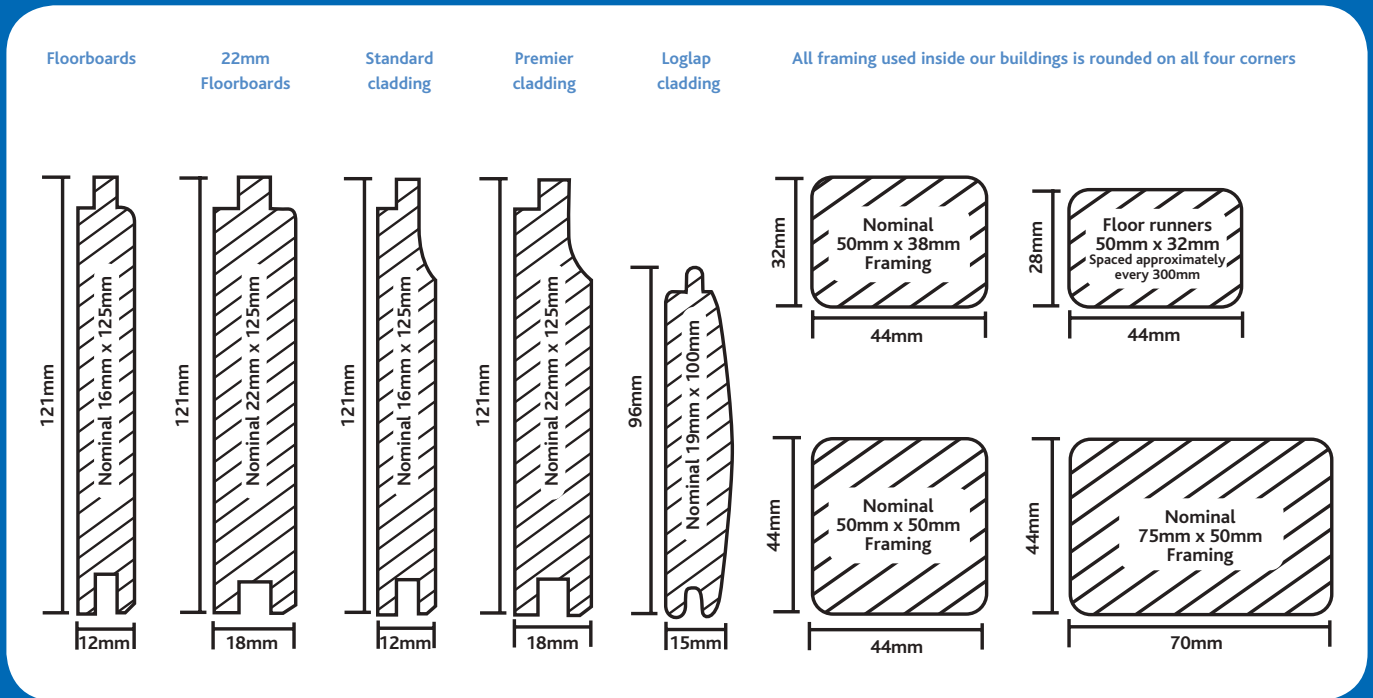

The finished sizes of our product are accurate to +/- 1mm.

**PLEASE NOTE:**

Buildings are available in all timber specifications and can be manufactured to your individual requirements. All measurements in the brochure are internal eaves and ridge height and for planning application purposes, the external measurements including roof and floor joists will be required.

## We now offer an upgrade to pressure treated timber - Tanalised E - on all our products

Specifications of pressure treated timber used. All sizes are nominal (before machining) unless otherwise stated.

**Main Features**

- All pressure treated buildings are manufactured using 15mm finished cladding with an extended 10mm tongue.
- Protected by a unique, highly developed preservative formulation, TANALISED E pressure treated timber gives a reliable and consistent protection against fungal decay and insect attack.
- Appealing natural pale green colour with excellent weathering properties.
- Usually specified for indoor and outdoor applications where there is a medium to high risk of fungal decay and insect attack, e.g. general construction, landscaping and leisure timbers, fencing and other outdoor timber projects.
- TANALISED E is tested in accordance with the requirements of BS EN599 and new European standards.
- TANALISED E is acknowledged globally on performance for long term protection against decay and insect attack

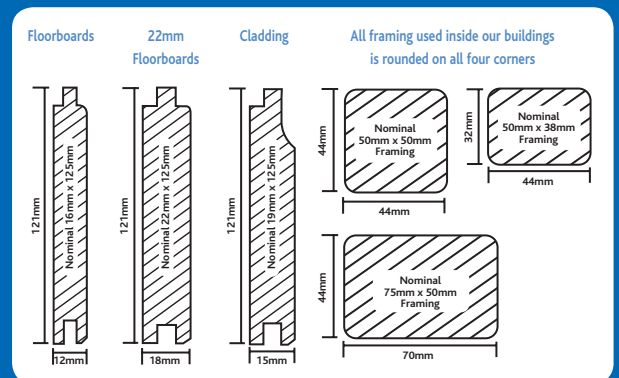















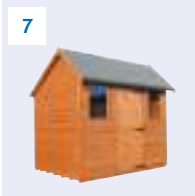















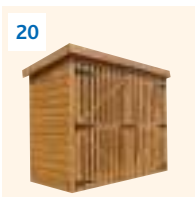

The finished sizes of our product are accurate to +/- 1mm.

**Guarantee**

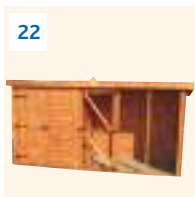
- Minimum 15 year guarantee against general timber rot and decay - the guarantee does not cover against splits or movement which may occur naturally over time.
- All buildings must be installed correctly using manufacturers instructions and treated annually using correct water repellent preservative and all windows to be made water tight using silicone or sealant to maintain validity of the guarantee.

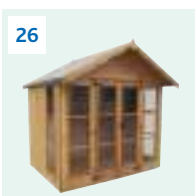
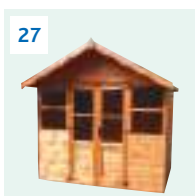
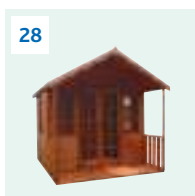
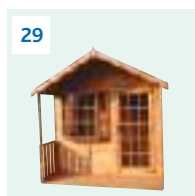

# contents

|  |  |   |  |  |
|--|--|---|--|--|
| sheds  | 5     | 5     | 6     | 6     |
| 7     | 8     | 9     | 9     | 10    |
| 11    | 12    | 13    | 13    | 14    |
| 14   | 15   | 16   | 16   | 17   |
| 18  | storage & kennels  | 19  | 19  | 20  |
| 20  | 21  | 21  | 21  | 22  |
| 22  | 23  | summer houses   | 24  | 25  |
| 26  | 27  | 28  | 29  | 30  |



# contents

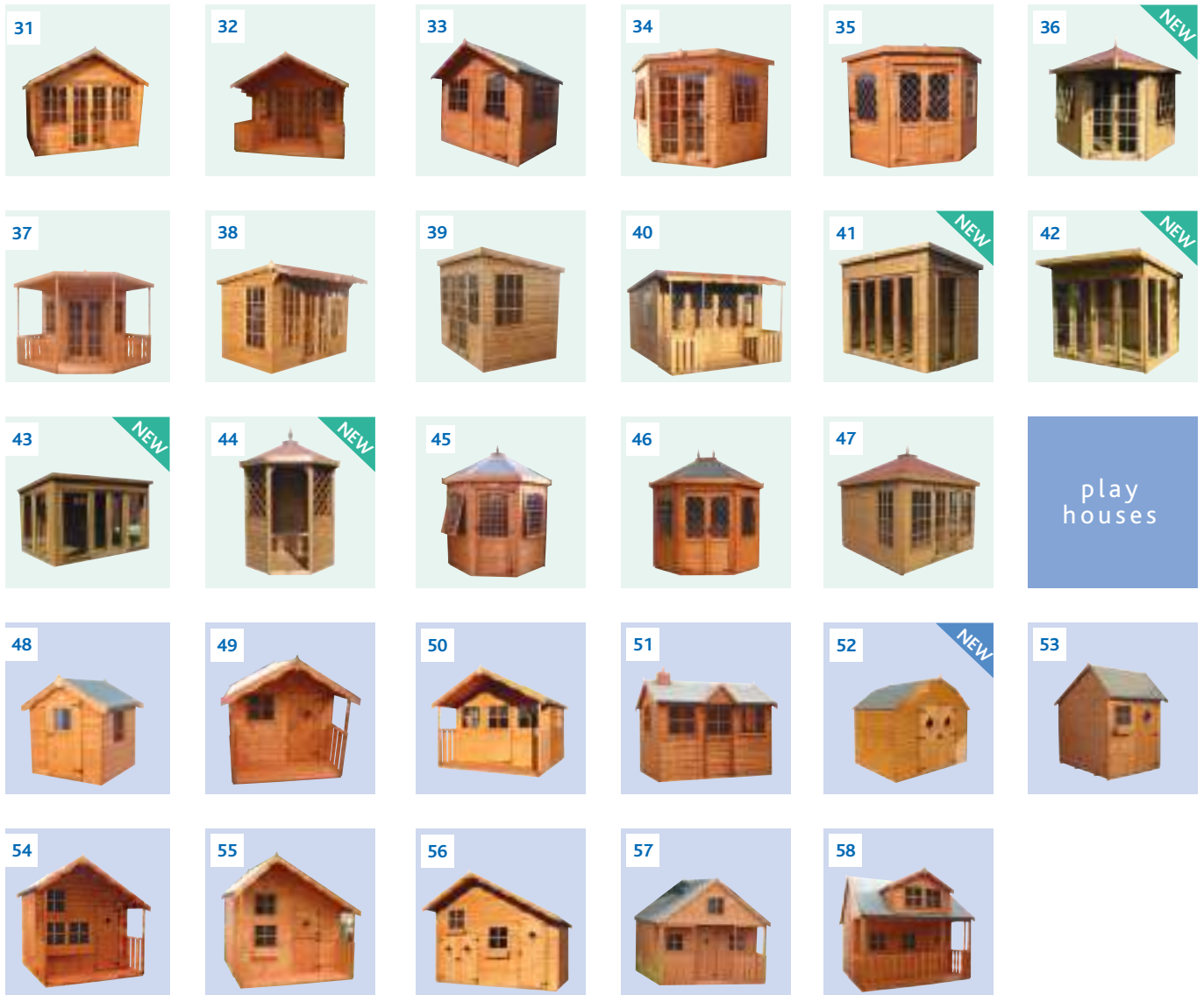

- 5 Superior Apex
- 5 Standard Apex
- 6 Superior Pent
- 6 Standard Pent
- 7 Hipex
- 8 Cabin
- 9 Bentley Supreme Apex
- 9 Bentley Supreme Pent
- 10 Potting Shed
- 11 Combi-Potting Shed
- 12 Sunflower
- 13 Security Apex
- 13 Security Pent
- 14 Heavy Duty Apex
- 14 Heavy Duty Pent
- 15 Garage Apex and Pent
- 16 Rhino Apex

- 16 Rhino Pent
- 17 Groundsman
- 18 Corner Cabin
- 19 Garden Store
- 19 Garden Tidy
- 20 Garden Chest
- 20 Wheelie Bin Store
- 21 Dog Kennel
- 21 Animal Arc
- 21 Deluxe Apex Kennel and Run
- 22 Pent Kennel and Run
- 22 Hen House
- 23 Traditional Dutch Barn
- 24 Summer Cabin
- 25 Althorpe
- 26 Ascot
- 27 Balmoral

- 28 Chatsworth
- 29 Buckingham
- 30 Windsor
- 31 Kensington
- 32 Wentworth
- 33 The Elton Home Office
- 34 Corner Summer House Georgian
- 35 Corner Summer House Leaded
- 36 Hipped Roof Corner Summerhouse
- 37 Blenheim Corner Summerhouse
- 38 Pavilion
- 39 Pent Summer House
- 40 Dual Pent Summerhouse
- 41 Pent Summerhouse with Folding Doors
- 42 Sunningdale

- 43 The Sunroom
- 44 Octagonal Arbour
- 45 Octagen 8 + 10
- 46 Stretched Octagonal 8
- 47 Sandringham
- 48 Toddlers Retreat
- 49 My Little Den
- 50 Ladybird Cottage
- 51 Snowdrop Cottage
- 52 Min Barn
- 53 Escape
- 54 Wilton Lodge
- 55 Candy Cabin
- 56 The Hideaway
- 57 Charleys Castle
- 58 Kids Club House

**PLEASE NOTE:** All our playhouses conform to trading standards BS5665 and are fitted with the CE mark  
 Safety features include: acrylic safety glass with planed and rounded corners on all the framing, staircases with horizontal tread, and hand rails. Doors are fitted with anti trap plastic strip to prevent finger injury.



A



B



C



D



E



### SUPERIOR APEX STANDARD FEATURES

Fully tongue and grooved construction  
 Door can be positioned on any side or end wall  
 Ledged and braced door  
 Lock and key  
 Interchangeable panels

### SPECIFICATION

Sizes from:  
 1.22m x 1.22m (4' x 4') up to  
 3.66m x 2.44m (12' x 8')  
 Eaves Height 1864mm  
 Ridge Height  
 4' Front - 86" / 2190mm  
 5' - 89" / 2260mm  
 6' - 92" / 2336mm  
 8' - 97" / 2475mm  
 Door 1880mm x 762mm  
 Windows 610mm x 457mm  
 Framing 38mm x 50mm  
 Cladding 16mm x 125mm

### OPTIONS AVAILABLE

22mm premier cladding  
 19mm Log Lap cladding  
 22mm Heavy duty floor  
 50mm x 50mm framing  
 Security options  
 Opening window  
 Felt options  
 Tanalised Timber

## Superior & Standard Apex



### Standard Apex -

If door option B,C or D are chosen then the height of the door is reduced by 190mm to 1575mm x 762mm.

### STANDARD APEX STANDARD FEATURES

Fully tongue and grooved construction  
 Ledged and braced door  
 Lock and key  
 Interchangeable panels

### SPECIFICATION

Sizes from:  
 1.22m x 1.22m (4' x 4') up to  
 3.66m x 2.44m (12' x 8')  
 Eaves height 1680mm  
 Ridge height  
 4' Front - 78" / 1985mm  
 5' - 81" / 2050mm  
 6' - 85" / 2160mm

8' - 90" / 2280mm  
 Door 1765mm x 762mm  
 Windows 610mm x 457mm  
 Framing 38mm x 50mm  
 Cladding 16mm x 125mm

### OPTIONS AVAILABLE

22mm premier cladding  
 19mm Log Lap cladding  
 22mm Heavy duty floor  
 50mm x 50mm framing  
 security options  
 opening window  
 Stable Door  
 Felt options  
 Tanalised Timber

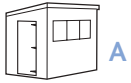

A

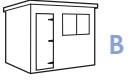

B

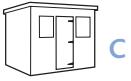

C

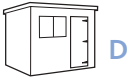

D

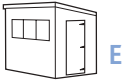

E



V



W



X



Y

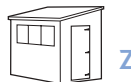

Z



**SUPERIOR PENT  
STANDARD FEATURES**

3" x 2" Framed roof  
Fully tongue and grooved construction  
Door can be positioned on any side or end wall  
Lock and key

**SPECIFICATION**

Sizes from:  
1.22m x 1.22m (4' x 4') to  
3.66m x 2.44m (12' x 8')  
Eaves height 1937mm  
Ridge height 2153mm  
Door 1880mm x 762mm  
Windows 610mm x 457mm  
Framing 38mm x 50mm  
Cladding 16mm x 125mm

**OPTIONS AVAILABLE**

22mm premier cladding  
19mm Log Lap cladding  
22mm Heavy duty floor  
50mm x 50mm framing  
Security options  
Felt options  
Tanalised Timber

Superior &  
Standard Pent

**STANDARD PENT  
STANDARD FEATURES**

3" x 2" Roof  
Fully tongue and grooved construction  
Door can be positioned on any side or end wall  
Lock and key

**SPECIFICATION**

Sizes from:  
1.22m x 1.22m (4' x 4') to  
3.66m x 2.44m (12' x 8')  
Eaves height 68" / 1737mm  
Ridge height 76" / 1953mm  
Door (front) 1765mm x 762mm  
Door (to 4ft end) 1690mm x 762mm



Windows 610mm x 457mm  
Framing 38mm x 50mm  
Cladding 16mm x 125mm

**OPTIONS AVAILABLE**

22mm premier cladding  
19mm Log Lap cladding  
22mm Heavy duty floor  
50mm x 50mm framing  
Security options  
Felt options  
Tanalised Timber



## Hipex

### STANDARD FEATURES

Fully tongued and grooved construction  
 Door can be positioned on front or either end wall  
 Ledged and braced door  
 Lock and key

### SPECIFICATION

Sizes from 2.44m x 1.83m (8' x 6') up to 3.66m x 2.44m (12' x 8')  
 Eaves height at front 1964mm  
 Eaves height at back 1780mm  
 Ridge height  
 4' Front – 90" / 2290mm  
 5' – 93" / 2360mm

6' – 96" / 2436mm  
 8' – 101" / 2575mm  
 Door 1765mm x 762mm  
 Windows 610mm x 457mm  
 Framing 38mm x 50mm  
 Cladding 16mm x 125mm

### OPTIONS AVAILABLE

50mm x 50mm framing  
 22mm Premier Cladding  
 19mm Log Lap Cladding  
 22mm Heavy duty floor  
 Security options  
 Stable door  
 Felt options  
 Tanalised Timber





## Cabin

### STANDARD FEATURES

Front and side fixed windows  
 Roof overhang 1/305mm  
 Central door  
 Lock and key  
 Fully tongue and groove construction

### SPECIFICATION

Sizes from:  
 1.52m x 2.13m (5' x 7') up to  
 2.44m x 3.05m (8' x 10')  
 Eaves height 1680mm  
 Ridge height 6' Front - 85" / 2160mm  
 7' - 89" / 2270mm  
 8' - 90" / 2280mm  
 10' - 93" / 2370mm

Door 1765mm x 762mm  
 Windows 610mm x 457mm  
 Framing 38mm x 50mm  
 Cladding 16mm x 125mm

### OPTIONS AVAILABLE

50mm x 50mm framing  
 22mm premier cladding  
 19mm Log Lap cladding  
 22mm Heavy duty floor  
 2'6" or 4' verandah  
 Security options  
 Stable door  
 Felt options  
 Tanalised Timber



## Bentley's Supreme Apex and Pent

### PENT



#### STANDARD FEATURES

Diagonal bracing in the sides  
Diagonal bracing in the ends  
38mm x 50mm boxed framed door  
6'2" High door (available in either end)  
Standard press lock and key  
Zinc plated hinges  
3 fixed windows

#### APEX SPECIFICATION

Sizes from 2.44m x 1.83m (8' x 6') up  
to 3.66m x 2.44m (12' x 8')  
Eaves height 70" / 1778mm  
Ridge height 4' Front – 81" / 2078mm  
5' – 84" / 2143mm  
6' – 88" / 2253mm  
8' – 93" / 2373mm  
Door 1778mm x 914mm  
Windows 610mm x 457mm

Framing 38mm x 50mm  
Cladding 16mm x 125mm

#### PENT SPECIFICATION

Eaves height 1937mm  
Ridge height 2153mm

#### OPTIONS AVAILABLE

22mm Premier Cladding  
19mm Log Lap Cladding  
22mm Heavy duty floor  
Increased height options which  
enables the door to be positioned on  
any side wall  
Workshop upgrade to include 4' wide  
fully framed boxed door  
Felt options  
Tanalised Timber

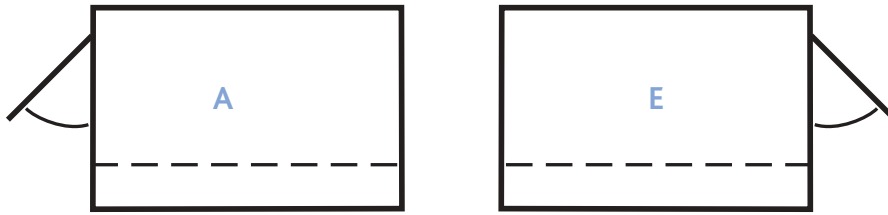

## Potting Shed

### STANDARD FEATURES

- 3" x 2" Framed roof
- Full length slatted staging under window
- Stable door
- Opening window in one end
- Lock and key

### SPECIFICATION

- Sizes from:
- 1.83m x 1.83m (6' x 6') to
- 3.05m x 2.44m (10' x 8')
- Eaves height 73" / 1854mm
- Ridge height 81" / 2058mm
- Door 1765mm x 762mm

- Windows 6' - 1530 x 1200mm
- 8' - 2160mm x 1200mm
- 10' - 2750mm x 1200mm
- Framing 38mm x 50mm
- Cladding 16mm x 125mm

### OPTIONS AVAILABLE

- Toughened glass
- 22mm premier cladding
- 50mm x 50mm Framing
- 22mm Heavy duty floor
- Door available at either end of building
- Felt options
- Tanalised Timber

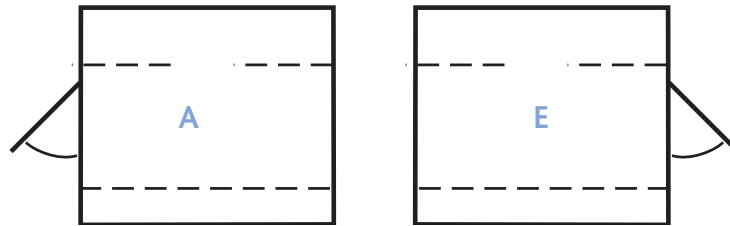

## Combi-Potting Shed



Internal sliding door

### STANDARD FEATURES

- 3" x 2" Framed roof
- Full length slatted staging under window
- Stable door
- Opening window in one end
- Integrated 4ft wide storage room with access via internal sliding door
- 2 - 4ft parallel shelves in storage room
- Profiled fascias

### SPECIFICATION

- Sizes from 2.44m x 3.05m (8' x 10') to 3.66m x 3.66m (12' x 12')
- Eaves height 2112mm / 83"
- Ridge height 2307mm / 91"
- Stable door 1765mm x 762mm

- Internal sliding door 1810mm x 762mm
- Windows 6' - 1530mm x 1200mm / 8' - 2160mm x 1200mm / 10' - 2750mm x 1200mm
- Framing 50mm x 50mm
- Cladding 16mm x 125mm

### OPTIONS AVAILABLE

- Toughened glass
- 22mm Premier cladding
- Framing 75mm x 50mm
- 22mm Heavy duty floor
- Door available at either end
- Felt options
- Tanalised Timber



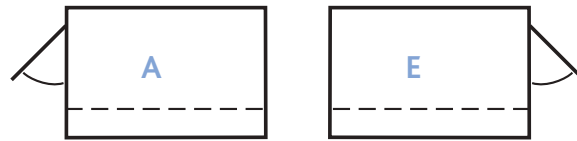

## Sunflower

### STANDARD FEATURES

- 3" x 2" Framed roof
- Full length slatted staging under window
- Full height windows returning at both ends
- Two joinery opening windows
- Lock and Key

### SPECIFICATION

- Sizes from:
- 1.83m x 1.83m (6' x 6') to
- 3.05m x 2.44m (10' x 8')
- Eaves height 73" / 1860mm
- Ridge height 81" / 2057mm

- Door 1765mm x 762mm
- Windows 6' - 1645mm x 905mm
- 8' - 2220mm x 905mm
- 10' - 2805mm x 905mm
- Framing 38mm x 50mm
- Cladding 16mm x 125mm

### OPTIONS AVAILABLE

- 22mm premier cladding
- 22mm Heavy duty floor
- 50mm x 50mm framing
- Stable door
- Door available at either end of building
- Felt options
- Tanalised Timber

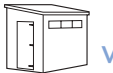
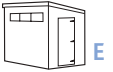
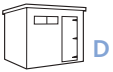
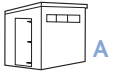

## Security Apex and Pent

### PENT



#### STANDARD FEATURES

Framing at 1'-300mm intervals throughout the sides for increased strength  
 38mm x 50mm diagonal bracing in gable ends  
 Galvanised bolted hinges  
 Security bolted padbolt protector  
 Internal glazed security window

#### APEX SPECIFICATION

Sizes from:  
 1.22m x 1.22m (4' x 4') to  
 3.66m x 2.44m (12' x 8')  
 Eaves height apex 1864mm  
 Ridge height apex 6' Front - 92" / 2350mm  
 8' - 97" / 2475mm  
 Door 1880mm x 762mm

Windows 1220mm x 150mm  
 Framing 38mm x 50mm  
 Door fully framed and braced in 50mm x 50mm framing  
 Cladding 16mm x 125mm

#### PENT SPECIFICATION

Eaves ht 76" / 1937mm  
 Ridge ht 84" / 2153mm

#### OPTIONS AVAILABLE

50mm x 50mm framing  
 22mm premier cladding  
 Felt options  
 Tanalised Timber  
 Loglap cladding

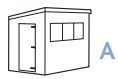

A

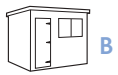

B

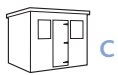

C

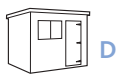

D

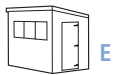

E

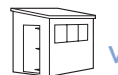

V



W



X



Y



Z



A



B



C



D



E

**Please note:** this model is shown with the 4ft double doors upgrade



## Heavy Duty Apex and Pent

### PENT



**Please note:** this model is shown with the 4ft double doors upgrade

### STANDARD FEATURES

50mm x 50mm framing throughout with diagonal bracing  
Substantial 75mm x 50mm roof truss: (as pictured)  
1 up to 15ft  
3 up to 20ft  
5 up to 30ft  
Heavy duty roofing felt  
Joinery windows

### APEX SPECIFICATION

Sizes from:  
3.05m x 2.44m (10' x 8') to  
9.14m x 3.66m (30' x 12')  
Eaves height 1895mm  
Ridge height 8' Front - 98" / 2490mm  
10' - 102" / 2595mm  
12' - 106" / 2690mm

Door 1880mm x 762mm  
Windows 610mm x 457mm  
Opening window 552mm x 400mm  
Framing 50mm x 50mm  
Cladding 16mm x 125mm

### PENT SPECIFICATION

Eaves height 76" / 1937mm  
Eaves height 84" / 2153mm  
Door 1880mm x 762mm

### OPTIONS AVAILABLE

22mm premier cladding  
22mm Heavy duty floor  
4', 5', 6' or 7' double doors  
Security options  
Felt options  
Tanalised Timber



## Garage



Pent Garage available on request

### STANDARD FEATURES

50mm x 50mm framing throughout with diagonal side bracing  
 Substantial 75mm x 50mm roof truss: (as pictured)  
 1 up to 15ft  
 3 up to 20ft  
 5 up to 30ft  
 Heavy duty roofing felt  
 Joinery windows  
 No floor

### SPECIFICATION

Sizes from:  
 3.05m x 2.44m (10' x 8') to  
 9.14m x 3.66m (30' x 12')  
 Eaves height 74" / 1895mm  
 Ridge height 8' Front - 94" / 2490mm  
 10' - 102" / 2595mm

12' - 106" / 2690mm  
 Double Doors 1880mm x 2135mm  
 Side Door 1775mm x 762mm  
 All doors are in 75mm x 50mm framing and braced  
 Windows 610mm x 457mm  
 Opening window 552mm x 400mm  
 Framing 50mm x 50mm  
 Cladding 16mm x 125mm

### OPTIONS AVAILABLE

22mm premier cladding  
 4', 5', 6' or 7' fully framed 75mm x 50mm double doors  
 With lock and key  
 Security options  
 Felt options  
 Tanalised Timber





## Rhino Apex and Pent



### STANDARD FEATURES

- 75mm x 50mm Fully framed door
- Roof constructed of 75mm x 50mm framing
- Door can be positioned at any side or end wall
- Mortice lock and key with antique handles
- 30" fully framed boxed door and fully boarded both sides
- Heavy duty hinges
- 75mm x 50mm framed roofing truss
- 3 fixed windows
- Heavy duty felt

### APEX SPECIFICATION

- Sizes from 2.44m x 1.83m (8' x 6') up to 3.66m x 2.44m (12' x 8')
- Eaves height 1.864m
- Ridge height

4' Front – 86" / 2190mm

5' – 89" / 2260mm

6' – 92" / 2336mm

8' – 97" / 2475mm

Door 1880mm x 762mm

Windows 610mm x 457mm

Framing 75mm x 50mm

Cladding 16mm x 125mm

### PENT SPECIFICATION

Eaves height 76" / 1937mm

Ridge height 85" / 2153mm

### OPTIONS AVAILABLE

22mm Premier Cladding

19mm Log Lap Cladding

22mm Heavy duty floor

Felt options

Tanalised Timber



## The Groundsman

### STANDARD FEATURES

4ft double doors boarded both sides,  
75mm x 50mm fully framed  
Roof constructed of 75mm x 50mm  
framing  
Doors can be positioned on any side  
or end wall  
Diagonal bracing to sides and ends  
(as pictured)  
Mortice lock and key with antique  
handles  
Heavy duty hinges  
75mm x 50mm Framed roof truss  
(as pictured)  
Joinery windows  
Untreated workbench (h) 825mm x  
(w) 1650mm x (d) 635mm (as pictured)  
Heavy duty felt

### APEX SPECIFICATION

Sizes from 2.44m x 1.83m (8' x 6') up

to 3.66m x 2.44m (12' x 8')

Eaves height 1.864m

Ridge height:

4' Front – 86" / 2190mm

5' – 89" / 2260mm

6' – 92" / 2336mm

8' – 97" / 2475mm

Door 1880mm x 1220mm

2 fixed windows 610mm x 457mm

1 opening window 552mm x 400mm

Framing 75mm x 50mm

Cladding 16mm x 125mm

### PENT SPECIFICATION

Eaves height 76" / 1937mm

Ridge height 85" / 2153mm

### OPTIONS AVAILABLE

22mm Premier Cladding

19mm Log Lap Cladding

22mm Heavy duty floor

Felt options

Tanalised Timber



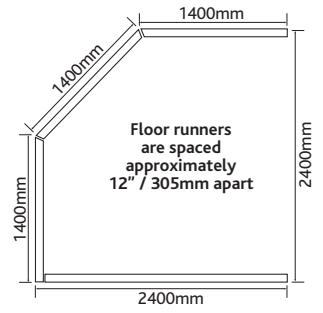
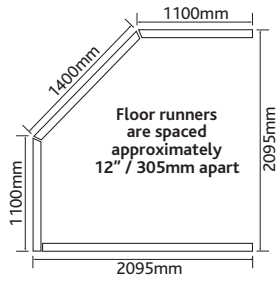
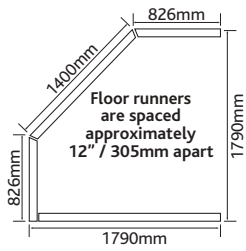

## Corner Cabin

### STANDARD FEATURES

3' wide door ledged and braced  
 50mm x 50mm door with rim lock,  
 door knob and 16" zinc coated door  
 hinges  
 Joinery opening windows

### SPECIFICATION

Eaves height 76" / 1937mm  
 Ridge height 84" / 2153mm  
 Door 1880mm x 914mm  
 Windows 610mm x 457mm  
 Framing 38mm x 50mm

### OPTIONS AVAILABLE

22mm Premier cladding  
 22mm Heavy duty floor  
 50mm x 50mm framing  
 Felt options  
 Tanalised Timber

## Garden Store



### STANDARD FEATURES

2' 6" Door  
Fully tongue and groove construction  
Door position on any side or end wall  
Lock and key  
Ledged and brace door

### SPECIFICATION

Size: 1.52m x 915mm (5'x3')  
Eaves height 1610mm  
Ridge height 1710mm  
Door 1460mm x 762mm  
Framing 38mm x 50mm  
Cladding 16mm x 125mm

### OPTIONS AVAILABLE

Doors available in any position  
22mm Premier cladding  
22mm floor boards  
Tanalised Timber  
Loglap Cladding  
Felt options

## Garden Tidy



### STANDARD FEATURES

4' double door  
Fully tongue and groove construction  
Lock and key  
Ledged and brace doors  
Roof can slope either way

### SPECIFICATION

Size: 1.83m x 762mm (6' x 2'6")  
Eaves height 1610mm  
Ridge height 1710mm  
Double doors 1460mm x 1320mm  
Framing 38mm x 50mm  
Cladding 16mm x 125mm

### OPTIONS AVAILABLE

22mm Premier cladding  
22mm floor boards  
Tanalised Timber  
Loglap Cladding  
Felt options



## Garden Chest



### STANDARD FEATURES

Hinged lid with hasp and staple  
Sliding internal storage shelf

### SPECIFICATION

Size: 1.52m x 610mm (5' x 2')  
Eaves height 710mm  
Ridge height 802mm  
Framing 38mm x 50mm  
Cladding 16mm x 125mm  
Tanalised Timber

### OPTIONS AVAILABLE

22mm Premier cladding  
22mm floor boards  
Tanalised Timber  
Loglap Cladding  
Felt options

## Wheellie Bin Store



### STANDARD FEATURES

Tower bolt fitted to each door  
Roof can slope either way  
Slatted doors to allow for ventilation  
No floor

### SPECIFICATION

Size: 2134mm x 915mm (7' x 3')  
Eaves height 1555mm  
Ridge height 1655mm  
Slated Double Doors 1550mm x 937mm (x2)  
Framing 38mm x 50mm  
Cladding 16mm x 125mm (to sides and back)  
Tower bolt fitted to each door

### OPTIONS AVAILABLE

22mm Premier cladding  
22mm floor boards  
Tanalised Timber  
Loglap Cladding  
Felt options

## Dog Kennel



### SPECIFICATION

sizes: 1.22m x 915mm  
(4' x 3')  
1.22m x 1.22m (4' x 4')  
Eaves height 660mm  
Ridge height 940mm

hole size 380mm x 305mm  
framing 38mm x 50mm  
cladding 16mm x 125mm

## Animal Arc



### SPECIFICATION

2 Sliding hatches, one at  
either end  
4' x 3' 5" (at base) Run  
with 13mm x 13mm  
galvanised wire mesh  
2'4 x 3' 5" (at base) Hut

with access hole  
Size 1930mm x 1041mm  
(6'4" x 3'5")  
Ridge 1016mm / 40"  
Doors 254mm x 279mm  
Internal access hole height  
190mm

## Deluxe Apex Kennel



### STANDARD FEATURES

4' x 6' kennel unit with floor  
and access door with closing  
bob hole  
6' x 6' run with 50mm x 50mm  
Galvanised weldmesh on  
50mm x 50mm framing, with front  
Access door  
Run designed with bottom drainage  
for easy cleaning

### SPECIFICATION

Size: 3.05m x 1.83m (10' x 6')  
Eaves height kennel 1780mm  
Eaves height run 1832mm  
Ridge height kennel 2250mm  
Ridge height run 2305mm  
Door in run 1757mm x 600mm  
Door in kennel 1765mm x 604mm  
Framing 50mm x 50mm  
Cladding 16mm x 125mm

### OPTIONS AVAILABLE

22mm premier cladding  
19mm Log Lap cladding  
22mm floorboards  
Tanalised Timber  
Felt Options

## Pent Kennel & Run



### STANDARD FEATURES

4' x 4' kennel with floor, front door and side with tower bolt

Dog access hole

Run made from 50mm x 50mm galvanised heavy duty wire mesh, on 50mm x 50mm framing,

Door with tower bolt

### SPECIFICATION

Sizes: 3.05m x 1.22m (10' x 4') and 3.66m x 1.22m (12' x 4')

Eaves height 1433mm

Ridge height 1610mm

Doors 1455mm x 596mm

Framing kennel 38mm x 50mm

Framing run 38mm x 50mm and 50mm x 50mm

Cladding 16mm x 125mm

### OPTIONS AVAILABLE

22mm premier cladding

19mm Log Lap cladding

22mm floorboards

Run on left side opposite to main picture

6' or 8' run

Tanalised Timber

Felt Options



## Hen House



### STANDARD FEATURES

3' X 6' Hen house with raised floor and single door. Separate closing

hen access door and ramp

3' x 6' run with 13mm x 13mm

Galvanised weldmesh, and meshed door

### SPECIFICATION

Size: 1.83m x 1.83m (6' x 6')

Eaves height 69<sup>1</sup>/<sub>4</sub>" / 1760mm

Ridge height 87<sup>3</sup>/<sub>4</sub>" / 2230mm

Meshed door 610mm x 1760mm

Single door in Hen house 1460mm x 915mm

Hen house access door 485mm x 380mm

Ramp 315 x 750

Framing 50mm x 50mm

Cladding 16mm x 125mm

### OPTIONS AVAILABLE

Attachable Nesting Box:

Size: 480mm x 1830mm (19" x 6")

Comprising of 3 nesting compartments each 585 mm x 355mm

Eaves height 31<sup>1</sup>/<sub>2</sub>" / 800mm

Ridge height 36<sup>1</sup>/<sub>2</sub>" / 927mm

22mm Premier cladding

19mm Log lap

22mm floorboards

Tanalised Timber

Felt Options





This model is shown with the coloured felt tiles upgrade

## Traditional Dutch Barn

### STANDARD FEATURES

Fully framed & braced 5ft barn style double doors  
Door knob handle  
Rim lock & key  
One fixed window above door  
Galvanised hinges  
16mm x 125mm shiplap cladding  
50mm x 50mm framing  
1 internal shelf 33" wide  
Green mineral felt (not shown in picture)  
18' x 18" toughened glass

### SPECIFICATION

Sizes available from 8ft x 6ft to 30ft x 10ft  
Eaves height on all sizes 1680mm / 66"  
Ridge height 6ft Front - 2605mm / 102"  
Ridge height 8ft - 2980mm / 117"  
Ridge height 10ft - 3355mm / 132"  
Door size 5ft double doors barn

style with 22mm tongue & grooved cladding  
Fixed Georgian window size 18" x 18" / 460mm x 460mm  
Framing 50mm x 50mm  
Cladding 16mm x 125mm

### OPTIONS AVAILABLE

Framing 75mm x 50mm  
22mm Premier cladding (as shown in picture)  
19mm Log lap  
22mm heavy duty floor boards  
Felt options including tiles (as shown in picture)  
Joinery opening side windows  
Additional fixed window in the rear apex  
Security option on door  
Additional shelving  
Tanalised Timber



Internal roof and shelf





## Summer Cabin

### STANDARD FEATURES

Roof overhang 1' / 305mm  
Four diamond leaded windows  
Stable door with ornate antique hinges  
Rim lock and knob handle  
Profiled fascia boards

### SPECIFICATION

Sizes from: 1.52m x 2.13m (5' x 7') to 2.44m x 3.05m (8' x 10')  
Eaves height 66" / 1680mm  
Ridge height 6' Front - 85" / 2160mm  
7' - 89" / 2270mm  
8' - 90" / 2280mm  
10' - 93" / 2370mm  
Door 1765mm x 762mm

Windows 610mm x 457mm

Framing: Up to 10' Front - 38mm x 50mm

12' and Over - 50mm x 50mm

Cladding 16mm x 125mm

### OPTIONS AVAILABLE

22mm premier cladding

19mm Log Lap Cladding

22mm floor boards

Veranda 2'6" or 4'

50mm x 50mm framing

Square leaded windows

Toughened glass

Felt options

Tanalised Timber



## The Althorpe

### STANDARD FEATURES

Half Glazed arched top doors with antique hinges, ornate handle and lever lock  
2 Arched top front fixed windows  
Door Drip  
Roof overhang 1' / 305mm

### SPECIFICATION

Sizes: 1.52m x 2.13m (5x7) and 2.13m x 2.13m (7x7) only  
Eaves height 73" / 1864mm  
Ridge height 91" / 2312mm  
Door 1790mm x 1103mm  
Windows 445mm x 1010mm  
Framing: Up to 10' Front - 38mm x 50mm

12' and Over - 50mm x 50mm  
Cladding 16mm x 125mm

### OPTIONS AVAILABLE

22mm Premier Cladding  
19mm Log Lap cladding  
22mm Heavy Duty Floor Boards  
2'6" or 4' Veranda  
Side window fixed or opening  
Square or diamond leaded windows  
Felt options  
Tanalised Timber



## The Ascot

### STANDARD FEATURES

Fully glazed plain glass double doors with antique hinges, ornate handle and lever lock

2 front fixed plain full length windows

2 side fixed plain full length windows

Roof overhang 1' / 305mm

Door drip

Profiled fascia boards

### SPECIFICATION

Sizes from 1.83m x 2.44m (6'x8') to 3.66m x 3.66 (12' x 12')

Eaves height 72" / 1838mm

Ridge height 8' Front – 97" / 2466mm,

10' – 102" / 2580mm,

12' – 106" / 2700mm

Doors 1790mm x 1103mm

Windows 1622mm x 452mm

Framing: Up to 10' Front - 38mm x 50mm

12' and Over - 50mm x 50mm

Cladding 16mm x 125mm

### OPTIONS AVAILABLE

Opening windows

22mm Premier cladding

19mm Log lap

22mm Floor boards

Toughened glass

50mm x 50mm Framing

2'6" or 4' Veranda



## The Balmoral

### STANDARD FEATURES

Half glazed joinery doors, with antique hinges, ornate handle and lever lock

4 front fixed windows

Roof overhang 1' / 305mm

Profiled fascia boards

Door drip

### SPECIFICATION

Sizes from: 1.83m x 2.44m (6' x 8') to 3.66m x 3.66m (12' x 12')

Eaves height 73" / 1864mm

Ridge height 8' Front / 98" / 2490mm

10' - 101" / 2570mm

12' - 104" / 2655mm

Double doors 1790mm x 1103mm

Windows: 7' Front 455mm x 403mm

8' 553mm x 400mm

10' and over 610 x 457mm

Framing: Up to 10' Front - 38mm x 50mm

12' and Over - 50mm x 50mm

Cladding 16mm x 125mm

### OPTIONS AVAILABLE

22mm premier cladding

19mm Log Lap Cladding

22mm floor boards

Toughened glass

50mm x 50mm framing

2' 6" or 4' veranda

Felt options

Tanalised Timber





## The Chatsworth

### STANDARD FEATURES

Fully glazed Georgian double doors with antique hinges, ornate handle and lever lock

2 front fixed Georgian windows, if building is a 10ft front the 2 fixed windows become opening windows as standard

2 top hung opening

Georgian side windows

Roof overhang 1' / 305mm

Door drip

Profiled fascia boards

### SPECIFICATION

Sizes from: 1.83m x 2.44m (6' x 8') to 3.66m x 3.66m (12' x 12')

Eaves height 73" / 1864mm

Ridge height 8' Front - 97" / 2466mm

10' - 102" / 2580mm

12' - 106" / 2700mm

Doors 1790mm x 1103mm

Windows 1010mm x 475mm

1040mm x 717mm

Framing: Up to 10' Front -  
38mm x 50mm

12' and Over - 50mm x 50mm

Cladding 16mm x 125mm

### OPTIONS AVAILABLE

22mm premier cladding

19mm Log Lap Cladding

22mm floor boards

Toughened glass

50mm x 50mm framing

2'6" or 4' veranda

Felt options

Tanalised Timber



## The Buckingham

### STANDARD FEATURES

Fully glazed georgian door with antique hinges, ornate handle and lever lock

Georgian bay window

1 Georgian top hung opening side window

Roof overhang 1' / 305mm

Profiled fascias

Door drip

### SPECIFICATION

Sizes from: 1.83m x 1.83m (6' x 8') to 3.66m x 3.66m (12' x 12')

Eaves height 73" / 1864mm

Ridge height 8' Front - 98" / 2490mm

10' - 101" / 2570mm

12' - 104" / 2655mm

Door 1790mm x 762mm

Windows 1040mm x 717mm

Bay window 1035mm x 1035mm

Framing: Up to 10' Front - 38mm x 50mm

12' and Over - 50mm x 50mm

Cladding 16mm x 125mm

### OPTIONS AVAILABLE

22mm premier cladding

22mm floor boards

Toughened glass

50mm x 50mm framing

19mm Loglap Cladding

2'6" or 4' veranda

Mirror image available

Felt options

Tanalised Timber



## The Windsor

### STANDARD FEATURES

Fully glazed georgian double doors, antique hinges, ornate handle and lever lock

Georgian bay window

2 Georgian top hung opening side windows

Roof overhang 1' / 305mm

Side wings 305mm

Profiled fascias

Door drip

### SPECIFICATION

Sizes from: 1.83m x 3.05m (6' x 10') to 3.66m x 3.66m (12' x 12')

Eaves height 73" / 1864mm

Ridge height 10' Front - 101" / 2570mm

12' - 104" / 2655mm

Double doors 1790mm x 1103mm

Windows 1040mm x 717mm

Bay window 1035mm x 1035mm

Framing: Up to 10' Front -

38mm x 50mm

12' and Over - 50mm x 50mm

Cladding 16mm x 125mm

### OPTIONS AVAILABLE

22mm premier cladding

19mm Log Lap Cladding

22mm floor boards

Toughened glass

50mm x 50mm framing

Mirror image available

Felt options

Tanalised Timber



This model is shown with the Loglap Cladding upgrade

## The Kensington

### STANDARD FEATURES

Fully glazed georgian double doors with antique hinges, ornate handle and lever lock  
2 Georgian front windows  
8ft front has 6 pane fixed  
10ft / 12ft front has 9 pane openers  
2 Georgian opening side windows  
Roof overhang 1' / 305mm  
Side wings 305mm  
Profiled fascias  
Door drip

### SPECIFICATION

Sizes from: 1.83m x 3.05m (6' x 10') to 3.66m x 3.66m (12' x 12')  
Eaves height 73" / 1864mm

Ridge height 8' Front - 98" / 2490mm  
10' - 101" / 2570mm  
12' - 104" / 2655mm  
Double doors 1790mm x 1103mm  
Windows 1040mm x 717mm  
Framing: Up to 10' Front - 38mm x 50mm  
12' and Over - 50mm x 50mm  
Cladding 16mm x 125mm

### OPTIONS AVAILABLE

22mm premier cladding  
22mm floor boards  
Toughened glass  
50mm x 50mm framing  
19mm Log Lap cladding  
Felt options  
Tanalised Timber





## Wentworth

### STANDARD FEATURES

Fully glazed georgian doors with antique hinges, ornate handle and lever lock  
2 Georgian fixed front windows  
2 top opening georgian side windows  
4' veranda with plant boxes and side wings  
Profiled fascia and veranda boards  
Door drip

### SPECIFICATION

Sizes from: 3.05m x 3.05m (10' x 10')  
to 4.87m x 3.66m (16' x 12')  
Eaves height 74" / 1891mm  
Ridge height 10' Front - 101" /

2560mm

12' - 104" / 2645mm

Double doors 1790mm x 1510mm

Windows 1010mm x 475mm

1040mm x 717mm

Framing 50mm x 50mm

Cladding 16mm x 125mm

### OPTIONS AVAILABLE

22mm premier cladding

19mm Log Lap Cladding

22mm floor boards

Toughened glass

Felt options

Tanalised Timber



## The Elton Home Office

### STANDARD FEATURES

Georgian half glazed door with arched inserts to accommodate double glazed units (not included)  
Heavy duty bolted black door hinges  
Door drip  
Georgian opening windows with arched inserts to accommodate double glazed units (not included)  
Roof overhang 1' / 305mm  
75mm x 50mm framing to sides and ends and braced  
Profiled fascias  
Substantial 75mm x 50mm roof truss (as pictured):

### SPECIFICATION

Sizes from: 2.44m x 3.05m (8' x 10')  
to 4.87m x 3.66m (16' x 12')  
Eaves height 82" / 2088mm

Ridge height 10' Front - 110" / 2790mm  
12' - 113" / 2865mm  
Door 1990mm x 762mm  
Front window 1000mm x 1043mm  
Side window 1413mm x 1043mm  
Framing 75mm x 50mm  
Cladding 16mm x 125mm

### OPTIONS AVAILABLE

22mm premier cladding  
19mm Log Lap cladding  
22mm floorboards  
Additional side window  
Double glazing  
Toughened glass  
Felt options  
Tanalised Timber

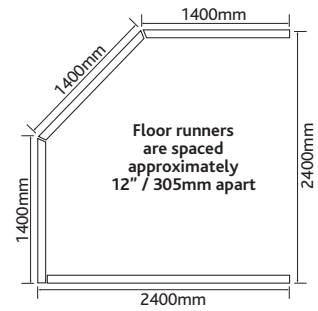
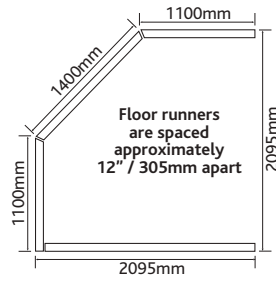
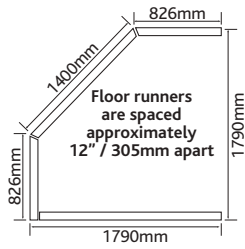

## Corner Summerhouse Georgian

### STANDARD FEATURES

Fully glazed Georgian double doors with antique hinges, ornate handle and lever lock

2 Georgian top opening side windows

Door drip

### SPECIFICATION

Sizes from: 1.83m x 1.83m (6' x 6')

2.13m x 2.13m (7' x 7')

2.44m x 2.44m (8' x 8')

Eaves height 76" / 1942mm

Ridge height 84" / 2146mm

Double doors 1790mm x 1103mm

Windows 1040mm x 717mm

Framing 38mm x 50mm

Cladding 16mm x 125mm

### OPTIONS AVAILABLE

22mm premier cladding

19mm Log Lap Cladding

22mm floor boards

Toughened glass

50mm x 50mm framing

Felt options

Tanalised Timber

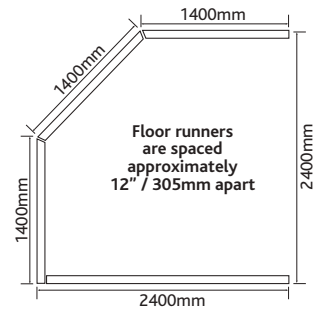
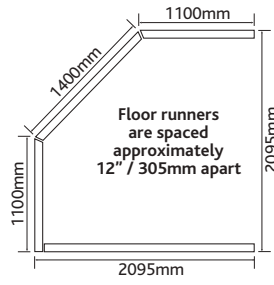
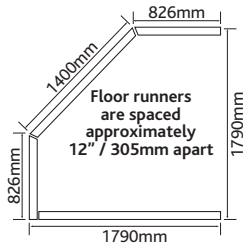

## Corner Summerhouse Leaded

### STANDARD FEATURES

Fully glazed double doors with leaded glass and antique hinges, ornate handle and lever lock

2 leaded glass top opening side windows

Door drip

### SPECIFICATION

Sizes from: 1.83m x 1.83m (6' x 6')

2.13m x 2.13m (7' x 7')

2.44m x 2.44m (8' x 8')

Eaves height 76" / 1942mm

Ridge height 84" / 2146mm

Double doors 1790mm x 1103mm

Windows 1040mm x 717mm

Framing 38mm x 50mm

Cladding 16mm x 125mm

### OPTIONS AVAILABLE

22mm cladding

19mm Log Lap Cladding

22mm floor boards

Toughened glass

50mm x 50mm framing

Felt options

Tanalised Timber



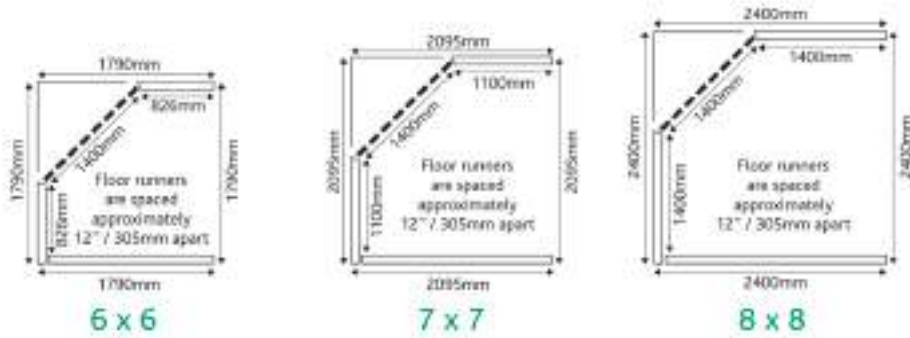

COLOURED TILE  
OPTIONS



BLACK



RED



GREY



GREEN



## Hipped Roof Corner Summerhouse



Internal roof structure

### STANDARD FEATURES

- 2 opening side windows
- Double doors
- Antique style ironmongery
- Overhang over the door
- Plain fascia board
- Felt tiled hipped roof
- Decorative corner covers
- Finial and plinth

### SPECIFICATION

- Sizes from (1.83m x 1.83M) 6ft x 6ft
- Eaves height 2130mm / 86"
- Ridge height on 6ft 3010mm / 120" (top of finial)
- Ridge height on 7ft 3120mm / 125" (top of finial)

- Ridge height on 8ft 3230mm / 130" (top of finial)
- Double doors 1790mm x 1103mm
- Windows 1040mm x 1717mm
- Framing 50mm x 38mm
- Cladding 16mm x 125mm
- Flooring 16mm x 125

### OPTIONS AVAILABLE

- 22mm Premier cladding
- 19mm Log lap cladding
- 22mm heavy duty floorz
- 50mm x 50mm framing
- 75mm x 50mm framing
- Choice of coloured felt tiles

## summer houses

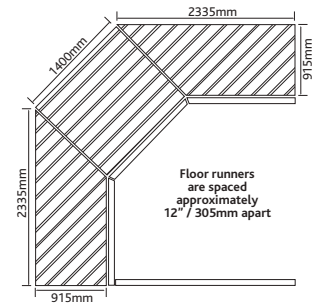
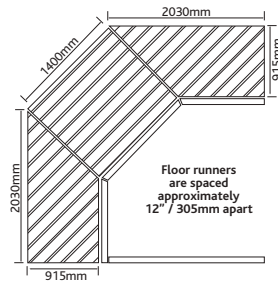
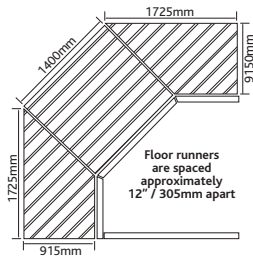

### Blenheim Corner



Option available without upright supports

#### STANDARD FEATURES

- Fully glazed Georgian double doors
- Antique hinges
- Ornate handle with lever lock
- 2 top hung side windows
- Door drip
- Includes 3' veranda with roof overhang
- Roof is boarded on the underside of veranda

#### SPECIFICATION

- Sizes available from 9ft x 9ft to 11ft x 11ft including 3ft veranda
- Eaves height 76" / 1942
- Ridge height 95" / 2410
- Doors 1790mm x 1103mm

#### OPTIONS AVAILABLE

- 22mm cladding
- 19mm Log Lap Cladding
- 22mm floor boards
- Toughened glass
- 50mm x 50mm framing
- Felt options
- Tanalised Timber

COLOURED TILE  
OPTIONS



BLACK



RED



GREY



GREEN



## Pavilion

### STANDARD FEATURES

Georgian double doors, antique hinges, ornate handle and lever lock

2 Georgian top hung 12 pane, opening side windows

2 front fixed Georgian windows

The front roof canopy is 485mm wide and tiled in red, green, black or slate tiles. The roof is felted with green roofing felt.

Profiled fascia boards

### SPECIFICATION

Sizes from 2.44m x 1.83m (8x6) up to 3.05m x 2.44m (10x8)

Eaves height 77" / 1950mm

Ridge height 88" / 2170mm

Double doors 1790mm x 1103mm

Windows 1360mm x 718mm

Framing: up to 10' end 38mm x 50mm, 12' end and above 50mm x 50mm

Cladding 16mm x 125mm

### OPTIONS AVAILABLE

22mm premier cladding

19mm Log Lap cladding

22mm Heavy Duty floor

Toughened Glass

50mm x 50mm framing

Felt options

Tanalised Timber



## Pent Summerhouse

### STANDARD FEATURES

Fully glazed Georgian double doors with antique hinges, ornate handle and lever lock

2 Georgian fixed front windows  
2 Georgian 9 pane opening side windows

Profiled fascias  
Door drip

### SPECIFICATION

Sizes from: 1.52m x 2.44m (5' x 8') to 3.05m x 4.87m (10 x 16)

Eaves height 76" / 1937mm (back pent)  
Ridge height 85" / 2153mm (front pent)  
Double Doors 1790mm x 1103mm  
Front windows 1010mm x 475mm

Side windows 1040mm x 717mm  
Framing: up to 10' end 38mm x 50mm, 12' end and above 50mm x 50mm  
Cladding 16mm x 125mm

### OPTIONS AVAILABLE

22mm Premier cladding  
19mm Log lap cladding  
22mm Floor boards  
50mm x 50mm framing  
2'6" veranda with fully tiled canopy in a choice of red, slate, green or black tiles  
Toughened Glass  
Choice of Georgian, diamond lead, or square lead glazing  
Tanalised Timber



COLOURED TILE  
OPTIONS



BLACK



RED



GREY



GREEN



## Dual Pent Summerhouse



### STANDARD FEATURES

Half glazed arch top double doors with antique hinges, ornate handle and lever lock  
 2 Arch top fixed front windows  
 2 Arch top opening side windows  
 Integrated 4' storage room with side access by security door  
 Galvanised bolted hinges & padbolt protector to side access door  
 Profiled fascias

### SPECIFICATION

Sizes from: 1.83m x 2.44m (6' x 8') to 4.87m x 4.87m (16 x 16)  
 Eaves height 76" / 1937mm  
 Ridge height 85" / 2153mm  
 Security door 1867mm x 908mm fully framed and braced in 50mm x 50mm framing  
 Double Doors 1780mm x 1103mm

(10' & above)

1780mm x 1103mm (8')  
 Front windows 445mm x 1010mm  
 Side windows 1040mm x 717mm  
 Framing: up to 10' end 38mm x 50mm, 12' end and above 50mm x 50mm  
 Cladding 16mm x 125mm

### OPTIONS AVAILABLE

22mm Premier cladding  
 19mm Log lap cladding  
 22mm Floor boards  
 2'6" veranda with fully tiled canopy in a choice of red, slate, green or black tiles  
 Toughened Glass  
 Choice of Georgian, diamond lead, or square lead glazing  
 Tanalised Timber  
 Felt Options



## Pent Summer House with Folding Doors



### STANDARD FEATURES

- Bi folding doors with 8ft front and Tri folding doors with 10ft front
- Toughened glass
- Green mineral felt
- Profiled fascias
- Door Drip
- 2 fixed side windows

### SPECIFICATION

- Size from 1.52m x 2.44m (5ft x 8ft) to 3.05m x 4.87m (10ft x 16ft)
- Eaves height 1937mm / 76" (back pent)
- Ridge height 2153mm / 85" (front pent)
- Bi folding doors 2005mm x 2555mm
- Tri folding doors 2555mm x 2555mm
- Framing 75mm x 50mm
- Cladding 16mm x 125mm

### OPTIONS AVAILABLE

- 22mm Premier Cladding
- 19mm Log Lap Cladding
- 22mm Heavy duty floor
- 50mm x 50mm Framing
- 2'6" Veranda with fully tiled canopy in a choice of red slate, green or black felt tiles
- Double glazed units
- Choice of Georgian, diamond or square leaded glazing
- Felt options
- Tanalised Timber



## Sunningdale

### STANDARD FEATURES

2 Fixed front windows  
4 Fixed side windows  
Double doors  
Toughened glass throughout  
Antique style ironmongery  
1ft (305mm) overhang on the  
pent roof  
Plain fascia board  
Standard mineral felt

### SPECIFICATION

Framing: up to 10' end 38mm x 50mm,  
12' end and above 50mm x 50mm  
Sizes from (2.44m x 1.83M) 8ft x 6ft  
Eaves height 1950mm / 77" (rear)  
Ridge height 2170mm / 88" (front)  
Roof overhang ridge 2220mm / 90"  
Doors 1790mm x 1170mm

Windows front 1647mm x 515mm  
Windows side 1647mm x 515mm  
Framing 50mm x 38mm  
Cladding 16mm x 125mm  
Flooring 16mm x 125mm

### OPTIONS AVAILABLE

22mm Premier cladding  
19mm Log lap cladding  
22mm Heavy duty floor  
50mm x 50mm framing  
75mm x 50mm framing  
Veranda  
Profiled fascia boards  
Tanalised Timber  
Felt Options





## The Sunroom



### STANDARD FEATURES

- Diagonal bracing
- 2 Fixed front windows with 3" x 2" casements
- 4 Fixed side windows with 3" x 2" casements
- 2 opening windows in rear
- Double doors to accommodate double glazing as windows
- Toughened glass throughout
- Chrome ironmongery
- Decorative fascia board
- Door drips
- Window cills
- Heavy Duty Felt

### SPECIFICATION

Sizes from (3.18m x 2.44M)  
10ft 5" x 8ft

- Eaves height 2030mm / 80" (rear)
- Ridge height 2220mm / 91" (front)
- Doors 1790mm x 1125mm
- Windows front 1740mm x 919mm
- Windows side 1740mm x 919mm
- Windows in rear 720mm x 405mm
- Framing 75mm x 50mm
- Cladding 22mm x 125mm
- Flooring 22mm x 125mm

### OPTIONS AVAILABLE

- 19mm Log lap cladding
- Canopy plus veranda
- Double glazed units
- Tanalised Timber
- Felt Options





## Octagonal Arbour



Internal roof structure

### STANDARD FEATURES

16mm x 125mm shiplap cladding  
50mm x 50mm angled  
and then planed framing  
1 internal seat  
Red mineral felt

### SPECIFICATION

Sizes available from 6ft x 6ft  
to 10ft x 10ft  
Eaves height on all sizes 2075mm/81"  
Ridge height 6ft – 2490mm/98"  
Ridge height 8ft – 2665mm /105"  
Ridge height 10ft – 2840mm /112"

### OPTIONS AVAILABLE

22mm Premier Cladding  
19mm Log lap Cladding  
22mm Heavy duty floor  
3 choices of lattice design  
Profiles fascia boards  
Felt options  
Tanalised Timber

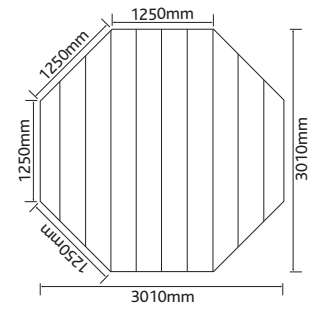
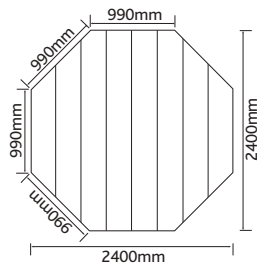

COLOURED TILE  
OPTIONS



BLACK



RED



GREY



GREEN



Octagonal 8  
and 10

RED TILE



STANDARD FEATURES

Half glazed joinery single door with antique hinges, ornate handle and lever lock

2 fully glazed top hung windows

2 fully glazed fixed windows

All side panels of the same size are fully interchangeable upon installation

Choice of tiled roof in red, slate, green or black

Door drip

Choice of georgian, diamond lead, or square lead glazing

SPECIFICATION

Size: 8' x 8' / 2440mm x 2440mm

Eaves height 80" / 2035mm

Ridge height 99" / 2535mm

Door 1790mm x 762mm

Windows 1040mm x 717mm

Framing 38mm x 50mm

Cladding 16mm x 125mm

OCTAGONAL 10 SPECIFICATION

size: 10' x 10' / 3050mm x 3050mm

Eaves height 80" / 2035mm

Ridge height 99" / 2535mm

Double doors 1790mm x 1103mm

OPTIONS AVAILABLE

22mm premier cladding

19mm Log Lap cladding

22mm Heavy duty floor

Toughened glass

Tanalised Timber

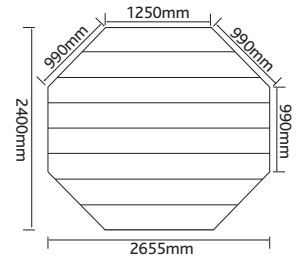

COLOURED TILE  
OPTIONS



BLACK



RED



GREY



GREEN

## Stretched Octagonal 8

### STANDARD FEATURES

- Half glazed double doors with antique hinges, ornate handle and lever lock
- 2 fully glazed top hung windows
- 2 fully glazed fixed windows
- Choice of tiled roof in red, slate, green or black
- Door drip
- Choice of Georgian, diamond lead, or square lead glazing

### SPECIFICATION

- size: 8' x 8'9" / 2440mm x 2667mm
- Eaves height 80" / 2035mm
- Ridge height 99" / 2535mm
- Door 1790mm x 1103mm
- Windows 1040mm x 717mm
- Framing 38mm x 50mm
- Cladding 16mm x 125mm

### OPTIONS AVAILABLE

- 22mm premier cladding
- 19mm Log Lap cladding
- 22mm floorboards
- Toughened glass
- Tanalised Timber



COLOURED TILE  
OPTIONS



BLACK



RED



GREY



GREEN



## The Sandringham

### STANDARD FEATURES

Georgian double doors to accommodate double glazing, antique hinges, ornate handle and lever lock  
2 Side 12 pane Georgian top hung opening windows to accommodate double glazing

2 Front 12 pane Georgian fixed windows to accommodate double glazing

The hipped roof comes with a choice of coloured felt tiles (not fitted)

Heavy duty 3" x 2" framing throughout

Toughened glass

### SPECIFICATION

Size 3.05m x 3.05 (10' x 10')

Eaves height 2160mm / 85"

Ridge height 3416mm / 136"

Double doors 1790mm x 1103mm

Windows 1360mm x 718mm

Framing 75mm x 50mm

Cladding 16m x 125mm

### OPTIONS AVAILABLE

22mm Premier cladding

19mm Log lap cladding

22mm Heavy duty floor

Coloured felt tiles with choice of Red, Green, Slate and Black

Double glazed units

Door and window options, plain, leaded and folding

Tanalised Timber





## Toddlers Retreat



### STANDARD FEATURES

Two side windows with acrylic  
Door window Square acrylic  
Profiled fascias  
Antique door handle and hinges with  
adjustable door catch

### SPECIFICATION

Size: 4' X 4' (1.2m x 1.2m)  
Eaves height 42<sup>1</sup>/<sub>4</sub>" (1074mm)  
Ridge height 54<sup>1</sup>/<sub>2</sub>" (1384mm)  
Door 1074mm x 596mm  
Side windows 457mm x 457mm  
Door window 305mm x 305mm  
Framing 38mm x 50mm  
Cladding 16mm x 125mm

### OPTIONS AVAILABLE

22mm Premier cladding  
19mm Log lap  
Window Box  
2' veranda  
Felt options  
Tanalised Timber  
50mm x 50mm Framing



## My Little Den



### STANDARD FEATURES

Door with diamond window, antique hinges and handle with adjustable door catch

2 acrylic Georgian windows

Roof overhang 1' / 305mm

Profiled fascias

### SPECIFICATION

Sizes from: 1.22m x 1.83m (4' x 6') to 2.44m x 1.83m (8' x 6')

Eaves height 51" / 1318mm

Ridge height 73" / 1850mm

Door 1282mm x 596mm

Windows 457mm x 457mm

Framing 38mm x 50mm

Cladding 16mm x 125mm

### OPTIONS AVAILABLE

22mm premier cladding

19mm Log Lap cladding

22mm floorboards

Window box

2' veranda (with or without) please specify

Additional fixed side window

Felt options

Tanalised Timber

50mm x 50mm Framing



## Ladybird Cottage



### STANDARD FEATURES

Georgian joinery door with antique hinges and handle, with adjustable door catch

4 acrylic Georgian windows

Roof overhang 1' / 305mm

Profiled fascia boards

### SPECIFICATION

Sizes from: 1.52m x 2.13m (5' x 7') to 2.74m x 2.13m (7' x 7')

Eaves height 49" / 1255mm

Ridge height 70" / 1790mm

Door 1180mm x 535mm

Windows 457mm x 457mm

Framing 38mm x 50mm

Cladding 16mm x 125mm

### OPTIONS AVAILABLE

22mm premier cladding

19mm Log Lap cladding

22mm floorboards

2' verandah (with or without) please specify

Felt options

Tanalised Timber

50mm x 50mm Framing



## Snowdrop Cottage



### STANDARD FEATURES

- Antique hinges and handle with adjustable door catch
- 4 acrylic Georgian windows
- Georgian joinery door with antique hinges and handle with adjustable door catch
- Chimney pot
- Hip roof
- Profiled fascia boards

### SPECIFICATION

- Sizes: 1.83m x 1.22m (6' x 4') and 2.13m x 1.52m (7' x 5')
- Eaves height 51" / 1318mm
- Ridge height 4' - 63" / 1615mm

- 5' - 70" / 1790mm
- Door 1180mm x 535mm
- Windows 457mm x 457mm
- Framing 38mm x 50mm
- Cladding 16mm x 125mm

### OPTIONS AVAILABLE

- 22mm premier cladding
- 19mm Log Lap cladding
- 22mm floorboards
- Felt options
- Tanalised Timber
- 50mm x 50mm Framing





## Mini Barn



Internal combined seat, bed and cupboard

### STANDARD FEATURES

- Garage style doors
- Windows in doors
- Internal cupboard
- Combined seat/bed
- Antique style ironmongery
- Anti-trap safety features
- Plain fascias
- Standard mineral felt

### SPECIFICATION

- Eaves height 1520mm / 60"
- Ridge height 2187mm / 87"
- Cupboard/bed height 580mm / 23"
- Windows 250mm x 250mm / 10" x 10"
- Double doors 1220mm x 1520mm / 48" x 60"

- Framing 38mm x 50mm
- Cladding 16mm x 125mm
- Floor and roof 16mm x 125mm

### OPTIONS AVAILABLE

- 22mm Premier cladding
- 19mm Log lap cladding
- 22mm ¾" flooring
- 50mm x 50mm framing
- 75mm x 50mm framing
- Felt Options
- Felt tiled roof (4 colour options)
- Profiled fascia boards
- Additional windows
- Tanalised Timber
- Painted options available



## Escape

CE



### STANDARD FEATURES

Full size door with 10" diamond window, antique hinges and handle  
Internal bunk bed with safety rail, ladder and hand rail (as pictured)  
1 Acrylic Georgian window  
1 Window box  
Profiled fascias

### SPECIFICATION

Size 2.44m x 1.83m (8' x 6')  
Eaves height 1964mm / 77"  
Ridge height 2436 / 96"  
Door 1765mm x 762mm  
Window 457mm x 457mm  
Framing 38mm x 50mm  
Cladding 16mm x 125mm

### OPTIONS AVAILABLE

22mm Premier cladding  
19mm Log lap cladding  
22mm Floor boards  
Additional side windows  
Mirror image available  
Felt options  
Tanalised Timber



## Wilton Lodge



### STANDARD FEATURES

Door with diamond window, antique hinges and handle, with adjustable catch

3 acrylic Georgian windows with large window box

Roof overhang 1' / 305mm

Internal bunk bed with safety rail, ladder and hand rail (as pictured)

Profiled fascias

### SPECIFICATION

Sizes from: 1.52m x 2.13m (5' x 7') to 2.74m x 2.13m (9' x 7')

Eaves height 56" / 1435mm to 70" / 1785mm

Ridge height 93" / 2350mm

Door 1410mm x 596mm

Windows 457mm x 457mm

Framing 38mm x 50mm

Cladding 16mm x 125mm

### OPTIONS AVAILABLE

22mm premier cladding

19mm Log Lap cladding

22mm floorboards

Side fixed windows

2' veranda (with or without) please specify

Mirror image available

Felt options

Tanalised Timber

50mm x 50mm Framing



## Candy Cabin



### STANDARD FEATURES

- Stable door with diamond in the top
- Antique hinges and handle with adjustable closing catch
- 2 acrylic Georgian windows
- 1 window box
- Internal bunk bed with safety rail, ladder with hand rail (as pictured)
- Profiled fascias
- Roof overhang 1' / 305mm

### SPECIFICATION

- sizes: 1.83m x 2.44m (6' x 8') and 2.44m x 2.44m (8' x 8')
- Eaves height 56" / 1435mm to 70" / 1785mm
- Ridge height 93" / 2360mm
- Stable door:

- Top 678mm x 596mm
- Bottom 730mm x 596mm
- Windows 457mm x 457mm
- Framing 38mm x 50mm
- Cladding 16mm x 125mm

### OPTIONS AVAILABLE

- 22mm premier cladding
- 19mm Log Lap cladding
- 22mm floorboards
- Side fixed window
- Window box
- Mirror image available
- 2' veranda (with or without) please specify
- Felt options
- Tanalised Timber
- 50mm x 50mm Framing







## The Hideaway



### STANDARD FEATURES

- Single and double garage doors with diamond windows, complete with antique hinges and handles
- 2 acrylic Georgian windows
- 2 window boxes
- Internal bunk bed with safety rail, ladder and hand rail (as pictured)
- Profiled fascias
- Roof overhang 1' / 305mm

### SPECIFICATION

- sizes: 1.52m x 3.05m (5' x 10')
- and 1.83m x 3.05m (6' x 10')
- Eaves height 56" / 1435mm to 70" / 1785mm
- Ridge height 96" / 2430mm
- Single door 1410mm x 596mm

- Double door 1042mm x 1158mm
- Windows 457mm x 457mm
- Framing 38mm x 50mm
- Cladding 16mm x 125mm

### OPTIONS AVAILABLE

- 22mm premier cladding
- 19mm Log Lap cladding
- 22mm floorboards
- Additional side windows
- Mirror image available
- Felt options
- Tanalised Timber
- 50mm x 50mm Framing





## Charleys Castle



### STANDARD FEATURES

- Door with antique hinges, handle and adjustable door catch
- Diamond window in door
- 3 front acrylic Georgian windows
- 1 side acrylic Georgian window
- Profiled fascias and veranda boards
- 2'6" veranda with front returns
- Internal bunk bed with safety rail, ladder and hand rail (as pictured)

### SPECIFICATION

- Sizes: 2.59m x 3.05m (8'6" x 10') and 3.2m x 3.05m (10'6" x 10') including 2'6" verandah

- Eaves height 66" / 1680mm
- Ridge height 110" / 2810mm
- Return veranda's 1070mm
- Door 1410mm x 596mm
- Windows 457mm x 457mm
- Framing 38mm x 50mm
- Cladding 16mm x 125mm

### OPTIONS AVAILABLE

- 22mm premier cladding
- 19mm Log Lap cladding
- 22mm floorboards
- Side fixed window
- Felt options
- Tanalised Timber



## Kids Club House



### STANDARD FEATURES

Door with antique hinges and handle with adjustable door catch  
 Diamond window in door  
 4 acrylic Georgian windows  
 Profiled fascias and veranda boards  
 3' veranda with side returns  
 Functional dormer window  
 Internal bunk bed with safety rail, ladder and hand rail (as pictured)

### SPECIFICATION

Sizes:  
 2.13m x 3.05m (7' x 10')  
 2.44m x 3.05m (8' x 10')  
 3.05m x 3.05m (10' x 10')  
 Eaves height 66" / 1680mm  
 Ridge height 110" / 2810mm

Door 1410mm x 596mm  
 Windows 457mm x 457mm  
 Framing 38mm x 50mm  
 Cladding 16mm x 125mm

### OPTIONS AVAILABLE

22mm premier cladding  
 19mm Log Lap cladding  
 22mm floorboards  
 Side fixed windows  
 Felt options  
 Tanalised Timber  
 50mm x 50mm Framing

# QUALITY BUILT TO LAST

Approved agent, stockist and distributor for Timber Garden Buildings Limited.

All contents of this brochure including photographs can only be reproduced with written permission and prior consent from Timber Garden Buildings Limited.



Timber Garden Buildings Limited  
Unit 2 Chesterton Road  
Eastwood Trading Estate  
Rotherham  
South Yorkshire  
S65 1SU

[info@tgbsheds.com](mailto:info@tgbsheds.com)  
[www.tgbsheds.com](http://www.tgbsheds.com)